

NANODUCT®
Neonatal Sweat Analysis
System

Instruction/Service Manual

57-0003-01A

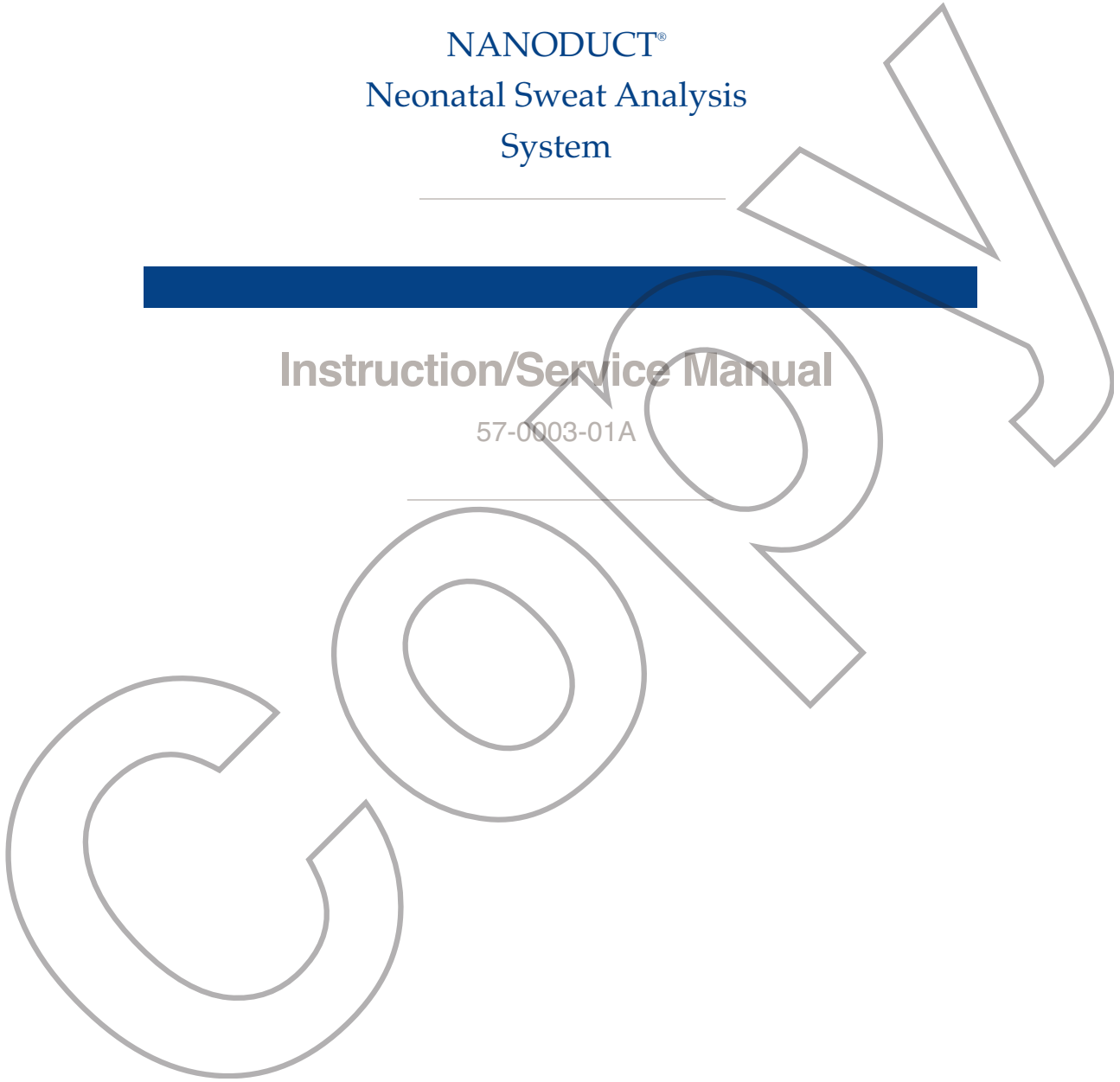

© 2006 Wescor, Inc. All rights reserved.
Printed in the United States of America.

Wescor, Nanoduct and Pilogel are trademarks of
Wescor, Inc.

Other trade names used in this manual may be
trademarks of their respective owners, used
here for information only.

U.S. Patent Number 6,198,953.

All information in this document is subject to
change without prior notice.

section

1 INTRODUCTION

- 1.1 Customer Service3
- 1.2 Important User Information4
- 1.3 System Description5

section

2 SWEAT INDUCTION AND ANALYSIS

- 2.1 Performing the Sweat Test13

section

3 INTERPRETING THE SWEAT TEST

- 3.1 Units of Conductivity25
- 3.2 Automatic Averaging27
- 3.3 Diagnostic Ranges28
- 3.4 Initial Sweating Rate29

TABLE OF CONTENTS

section

4 TROUBLESHOOTING AND MAINTENANCE

4.1 Troubleshooting	.33
4.2 Cleaning the Instrument	.34
4.3 Battery Replacement	.37
4.4 Calibration and Checking Control Values	.38

APPENDIX A

Instrument Specifications	.43
---------------------------	-----

APPENDIX B

Accessories, Supplies, and Replacement Parts	.47
--	-----

APPENDIX C

Supplemental Information	
Cystic Fibrosis: A Brief Description of the Disease	.51
Evolution of Sweat Test Methods	.52
Development of the Nanoduct Neonatal Sweat Analysis System	.54

APPENDIX D

Instrument Setup Menu	.59
-----------------------	-----

APPENDIX E

Pilocarpine Iontophoresis: Requirements and Risks	.65
---	-----

APPENDIX F

Serial Data Output	.69
--------------------	-----

INDEX	.73
-------	-----

SECTION 1
INTRODUCTION



1.1 Customer Service

Thank you for purchasing the Nanoduct Neonatal Sweat Analysis System. We believe it is the best diagnostic sweat testing system for newborns available. We are confident that you will be satisfied with our product.

Wescor is dedicated to assisting in every aspect of sweat testing theory and practice. Wescor is the acknowledged world leader in the development of innovative systems for cystic fibrosis diagnosis by sweat testing.

This manual contains basic maintenance, troubleshooting, and service information. Wescor is prepared to help you resolve any difficulty with the operation or performance of your Nanoduct Neonatal Sweat Analysis System. If you are unable to solve a problem using the procedures described in this manual, please contact us.

Customers should contact Wescor by telephone, fax, or e-mail. Outside the U.S., many of our authorized dealers offer customer service and support.

TELEPHONE

435 752 6011	Extension 0 - Operator
	171 - Orders
	172 - Service
	173 - Product Information & Pricing

TOLL FREE (US and Canada)

800 453 2725	Extension 0 - Operator
	171 - Orders
	172 - Service
	173 - Product Information & Pricing

FAX
435 752 4127

E-MAIL
service@wescor.com

WEBSITE:
www.wescor.com/biomedical

MAILING ADDRESS:
Wescor, Inc
Biomedical Products Division
459 South Main Street

1.2 Important User Information

This manual describes the complete procedure for the laboratory diagnosis of cystic fibrosis, particularly in the early neonatal period, through examination of sweat electrolyte concentration using measurement of electrical conductivity. Section 1 gives a brief description of the system and its components. Section 2 describes the procedure for stimulating and analyzing sweat. Section 3 gives needed information on the analysis of sweat. In addition, instructions for troubleshooting and maintenance of the system are provided in Section 4. A detailed description of the development of the Nanoduct System is presented in Appendix C.

INTENDED APPLICATION AND CLASSIFICATION

APPLICATION

The Nanoduct System is intended for laboratory use by qualified personnel to provide laboratory diagnosis of cystic fibrosis.

Anyone operating Nanoduct must be thoroughly familiar with the procedures and cautionary information detailed in this manual before attempting a sweat test. Abbreviated instructions printed elsewhere are provided for reference only. Do not use them as a substitute for the complete information contained in this manual.

CLASSIFICATION

This equipment is classified as Type BF Medical Equipment, Internally Powered.

SPECIFICATION OF SAFE USE:

Using this equipment in a manner not specified by Wescor may impair safety protection and may lead to injury. Do not use where flammable anesthetic is present or in any oxygen-enriched environment. Do not connect the serial port to external sources while the Nanoduct is connected to a patient.

STATEMENT OF ENVIRONMENTAL LIMITS

This equipment is designed to be safely operated at 15 to 30 °C, maximum relative humidity 80%.

EXPLANATION OF SYMBOLS FOUND ON EQUIPMENT



Type BF equipment complying with Medical Equipment Safety Standard EN60601-1.

1.3 System Description



1.3 System Description

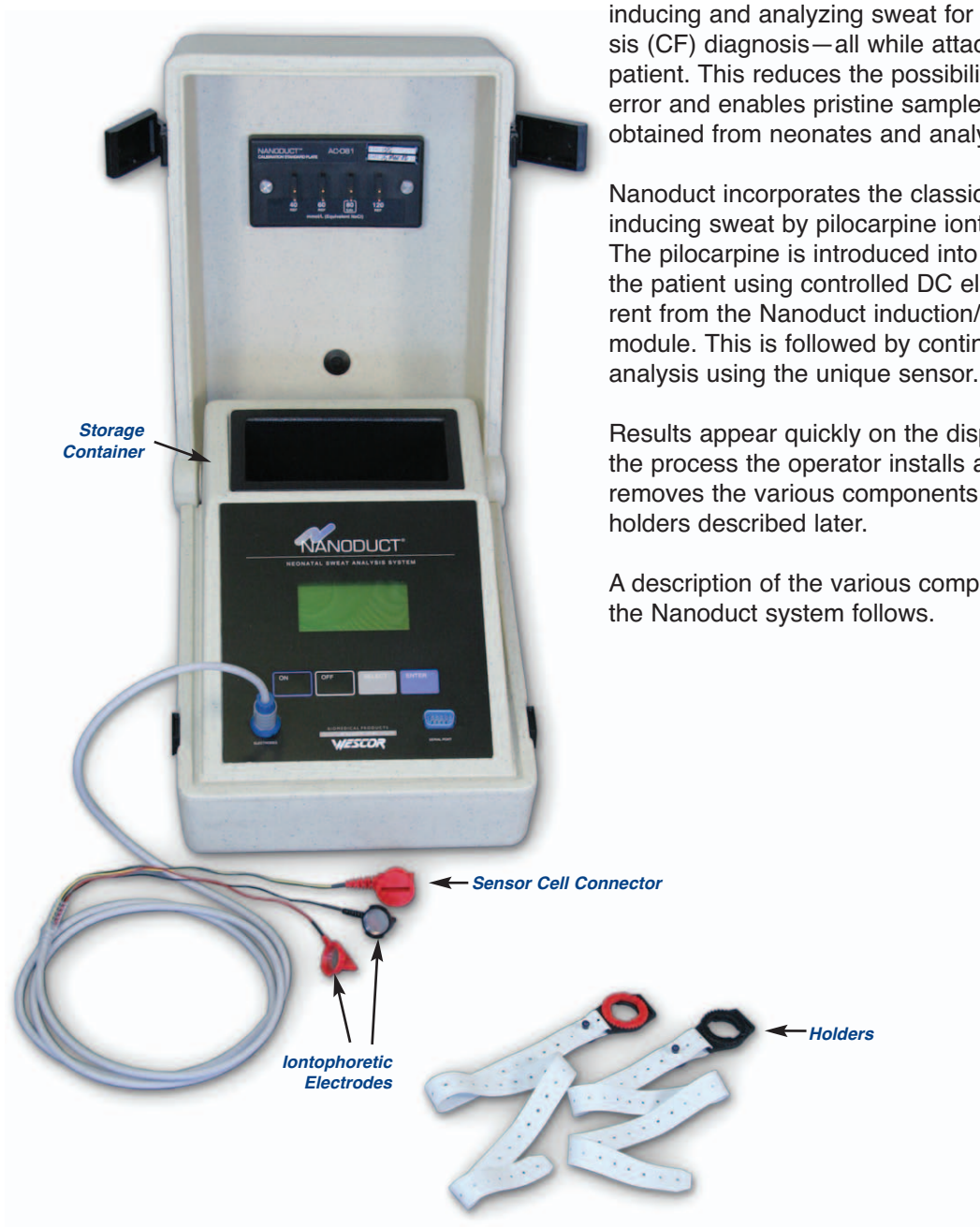

Nanoduct is a complete, integrated system for inducing and analyzing sweat for cystic fibrosis (CF) diagnosis—all while attached to the patient. This reduces the possibility of intrinsic error and enables pristine samples to be obtained from neonates and analyzed in situ.

Nanoduct incorporates the classic method of inducing sweat by pilocarpine iontophoresis. The pilocarpine is introduced into the skin of the patient using controlled DC electrical current from the Nanoduct induction/analysis module. This is followed by continuous-flow analysis using the unique sensor.

Results appear quickly on the display. During the process the operator installs and then removes the various components that fit in the holders described later.

A description of the various components of the Nanoduct system follows.

1.3 System Description

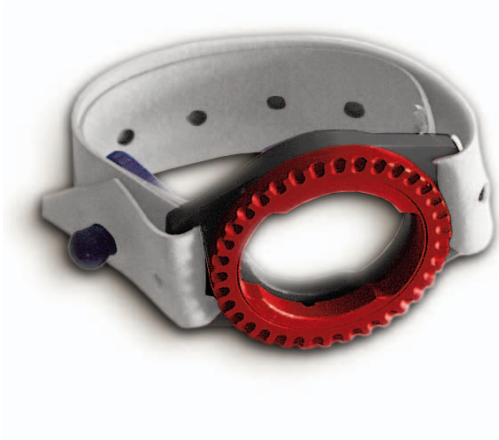

Holders

Two plastic holders are attached to the patient with comfortable but secure non-latex elastic straps. These holders accept the electrodes and later the sensor, holding them securely against the patient's skin. Holders are color-coded, one red to accept the (positive) anode and subsequently the red sensor; the other black to accept the (negative) cathode. Strap retainers are pushed through the holes in the strap to maintain the correct tension.



Iontophoretic Electrodes

Two color-coded electrodes, one red for the anode (positive) and the other black for the cathode (negative), are otherwise identical, both having a small stainless-steel disc as the electrode plate. These electrodes are part of the electrode cable assembly (see below) that also includes the sensor cell connector to attach the separate sensor cell. Both electrodes have projecting flanges, for securing the electrodes in the holder rings. Electrodes provide current from the module through Pilogel discs during iontophoresis. The black cathode electrode also serves as an electrical reference to detect sweat flow to the sensor cell during the analysis phase.



Electrode Cable Assembly

This dual purpose cable assembly includes the red anode and black cathode iontophoretic electrodes and also the red sensor cell connector. The cable connects to the Induction/Analysis Module at the electrode connection socket.

1.3 System Description

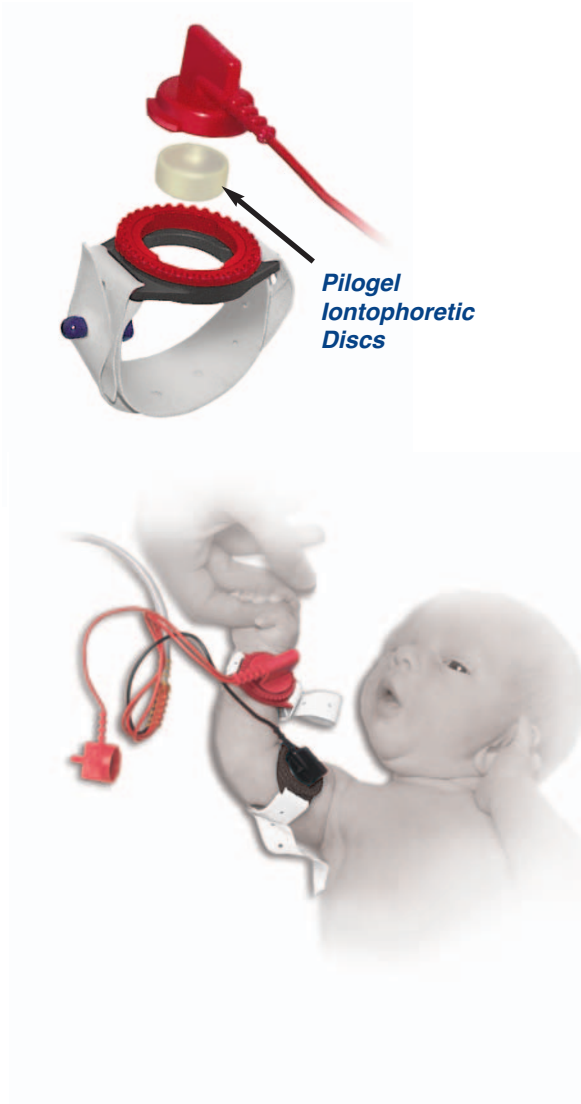

Pilogel® Iontophoretic Discs

Pilogel discs are small (surface area 2.5 cm²) iontophoretic discs that are inserted into the electrode assemblies prior to iontophoresis. These discs are designed especially for neonates, and have a pilocarpine concentration of 1.5 %, for optimum stimulation of the sweat gland and to reduce iontophoresis time to approximately 2.5 minutes.

Pilogel discs contain sufficient glycerol to provide substantial protection of gels against damage from accidental freezing. Cracked discs due to freezing can contribute to burns. See Appendix E for more information.

Pilogels contain trisodium citrate, an excellent buffer in the acid range of pH. This reduces anodic acidification of the gel during iontophoresis by 90%. At the cathode, the increased pilocarpine, a good buffer at moderately alkaline pH, also reduces iontophoretic accumulation of alkali. This buffering prevents skin burns due to pH change in the gel. Each of these features contribute to the safety of the procedure. See Appendix E for important information about pilocarpine iontophoresis.

Sensor Cell

Color-coded red, the sensor has two external flanges (as with the electrodes) for latching to the red holder. The base of the sensor is a shallow concavity leading at its center to an entry port, and from there to an internal fine channel passing by two analyzer micro-electrodes, forming a microconductivity cell.

The sensors pass through stringent quality controls before shipment to the customer. To be accepted, sensors must be highly consistent throughout each batch.

1.3 System Description



Electrode Socket



Front Panel Keypads

INDUCTION/ANALYSIS MODULE

The battery operated electronic induction/analysis module controls the Nanoduct system. The module performs 6 separate functions:

- Provides a timed and controlled current for iontophoretic sweat stimulation.
- Measures electrical conductivity of the excreted sweat during the analysis phase.
- Automatically averages the conductivity reading over a defined 5 minute period.
- Automatically computes the initial sweating rate.
- Displays the above information on the LCD readout and reports sweat test and calibration results to the serial port.
- Provides a time and date display for calibration and test results.

CONTROL AND CONNECTIONS

Electrode Socket

The electrode socket on the front panel of the induction/analysis module connects the electrode/sensor cable assembly to provide electrical current for sweat stimulation and to receive sensor signals to the induction/analysis module during the analysis phase.

Keypads

ON keypad controls power to the module. This must be on during iontophoresis and analysis.

OFF keypad terminates all operations and turns power to the module off.

Note:

To preserve battery power, leave power off except while performing a test. In addition, during idle periods the instrument shuts down automatically after 10 minutes and must be turned on again to complete testing or retrieve a result.

SELECT/ENTER

Used to select options and start the iontophoresis and analysis phases of the sweat test. A warning tone sounds if a fault condition occurs—such as an open electrode or circuit fault. The fault condition is displayed and reset by pressing **ENTER**.

1.3 System Description

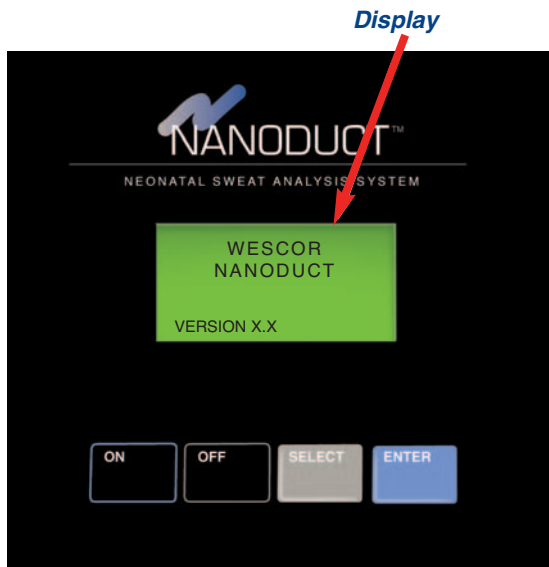

NOTE:
Date and time indications are in the format yyyy-mm-dd; hh:mm. Dates, times and other data shown in this manual are for example only, Actual data during use will vary.

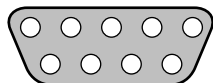

Serial Port

DISPLAY

The LCD alphanumeric read-out displays all functions and results as they occur, including iontophoresis status and analysis results, plus the time and date of the last procedure. The user responds to prompts on the display to activate various functions. The instrument emits a short beep tone at the start and end of each operation.

The instrument displays conductivity measurements in mmol/L (equivalent NaCl) during analysis. If desired, display readings can be suppressed so readings are not visible, but can be recalled at a later time.

LOW BATTERY Indicator

If the battery voltage drops below a preset level when the instrument is turned on, "Low Battery" appears on the display. When this indicator first appears you can usually complete 1 to 2 tests before a dead battery. If battery power is too low to complete a test, the module will automatically shut off and iontophoresis cannot be started. You must replace the battery to continue. See Section 4.3 for information.

Note:

The inducer/analyser is powered by one 9 Volt cell, which should provide a minimum of 100 tests with a standard alkaline battery, or 200 tests with a lithium battery.

SERIAL PORT Connector

The RS232 compatible connector can be used to print out results of sweat tests (with a time and date stamp). **Do not connect a line powered printer or computer when the instrument is attached to a patient.** See Appendix F for details.

SECTION 2
SWEAT INDUCTION
AND ANALYSIS



2.1 Performing the Sweat Test

IMPORTANT NOTE:

Check calibration before each session of use by using the instructions in Section 4.4.

WARNING!

Due to the remote possibility of ignition, never attempt iontophoresis on a patient receiving oxygen-enriched respiratory therapy in an enclosed space. With medical approval, remove the patient from that environment during iontophoresis.

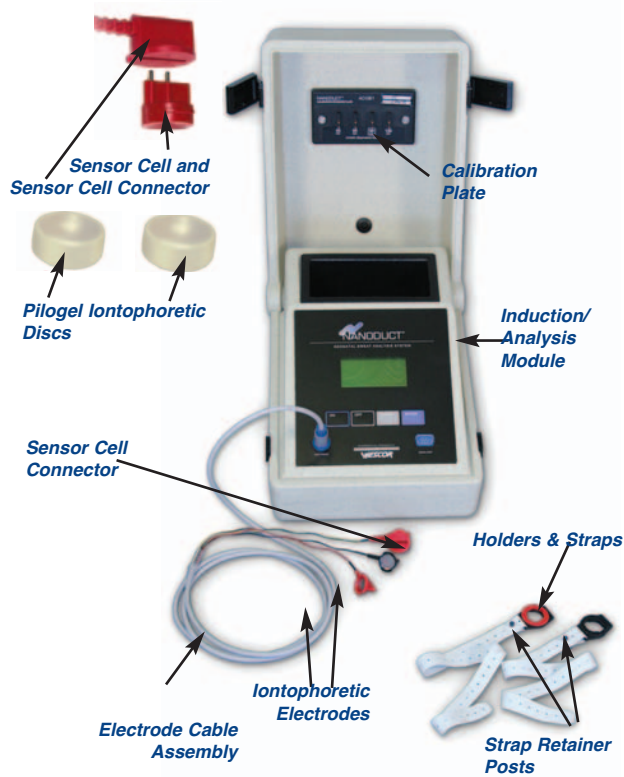

1

Assemble Equipment and Supplies

Make certain you have everything on hand for the complete procedure:

- Sweat induction/analysis module.
- Two holders.
- Two holder straps with strap retainer posts.
- Two Pilogel discs.
- One sensor.
- Electrode cable for connecting the iontophoretic electrodes or the sensor to the induction/analysis module.

You will also need a supply of deionized water, alcohol, cotton balls or gauze pads, and cotton swabs, and a roll of 1-inch wide plastic surgical tape (3M Transpore™ recommended). Make sure that the battery for the sweat inducer/analysis module is not dead, and that the gel discs are rubbery, translucent and not cracked or otherwise damaged.

2

Inspect Electrodes, Leads, and Cables

a. Clean the electrodes if necessary (see Section 4.2). Check the lead wires and insulation for damage.

b. Connect the electrode cable assembly to the electrode socket.



2.1 Performing the Sweat Test



3

Calibrate and Check Control Values

Turn the power on. Check for low battery condition on the display. The arrow on the display should indicate Check Controls on the menu.

We recommend checking control values (using the built in calibration plate) before each session. See Section 4.4 for details.

NOTE: *Selecting the FORCE CAL. option will bring up the Check Controls operation whenever the instrument is turned on. See Appendix D.*

4

Clean Selected Skin Areas

Select the anodic (positive) skin site for the greatest density of sweat glands. The site must be well-removed from the wrist where movement of tendons or ligaments could possibly affect the stability of the attached units. In neonates, the optimum site is the flexor aspect of the forearm, approximately half way between wrist and elbow. The cathodic (negative) electrode site is not as critical, place it an inch or two from the anode in the direction of the elbow.

WARNING!

Never place electrodes across the chest or on opposite limbs. Even though the DC iontophoretic current is extremely low, there is a very remote risk of interference with cardiac rhythms.

Inspect the selected sites. The skin should be free of fissures and any structural abnormality. There should be no inflammation or signs of eczema. Apart from exacerbating the complaint, there is always the possibility of contamination of the sweat by serous exudates.

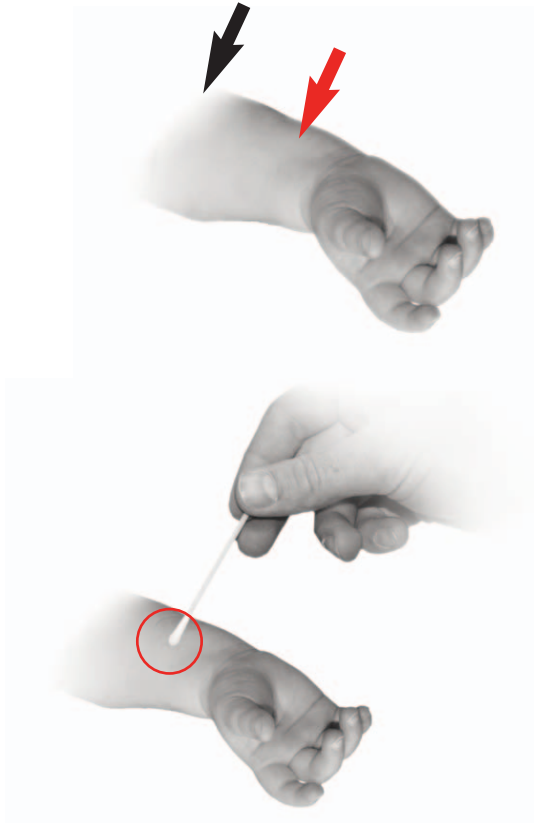

2.1 Performing the Sweat Test



To minimize the electrical impedance (resistance) of the skin, remove as much dead epithelial material, dirt and fatty substances as possible by swabbing the area vigorously with surgical alcohol, followed by plenty of distilled or deionized water. Then totally remove the excess water.

5 Attach the Holders

NOTE: Wescor provides perforated non-latex elastic straps of different lengths to fit infants, older children and adults.

To save time, pre-arrange strap holder assemblies to fit varying sizes of patients.

Select the red holder and attach a rubber strap of appropriate size as follows:

- a. Attach the strap to one side of the holder by inserting it, **from below**, through the holder slit, and down to form a small loop. Align two perforations in this loop and push a strap retainer post through the aligned holes such that the post points away from the patient's arm. (In use, the flat retainer base should rest against the skin of the patient.)
- b. Run the free end of the strap through the opposite slit **from below**. Hold this loop open as you run the arm of the patient up through the loop.
- c. Place the holder precisely over the cleaned skin site selected for sweat stimulation and hold it down while drawing the free end of the strap down and around the arm. Pull the strap to tighten, stretching slightly and affix it to the retainer post.

2.1 Performing the Sweat Test



- d. Grip the holder and lift it briefly above the skin to equalize strap tension on each side of the holder, then replace it on the skin surface. Adjust strap tension as needed to ensure correct contact.

NOTE *Attach the strap firmly, but avoid excessive tightness. Correctly applied, the holder should grip the skin firmly enough to resist moderately forceful attempts to change its position. The surrounding skin areas should move with the holder when it is moved.*



- e. Draw the skin back around the holder to remove any underlying wrinkles.
- f. Position the negative (**black**) holder (on the same limb) in the same manner.

6

Insert Pilogels Into the Iontophoretic Electrodes

Insert a gel into each electrode assembly. Press lightly and rotate to ensure an air-free and moist interface between electrode plate and gel.



7

Insert Each Electrode Into Its Holder

Fit the red (positive) anode into the holder with the red locking ring and fit the black (negative) cathode into the holder with the black locking ring as follows:

2.1 Performing the Sweat Test

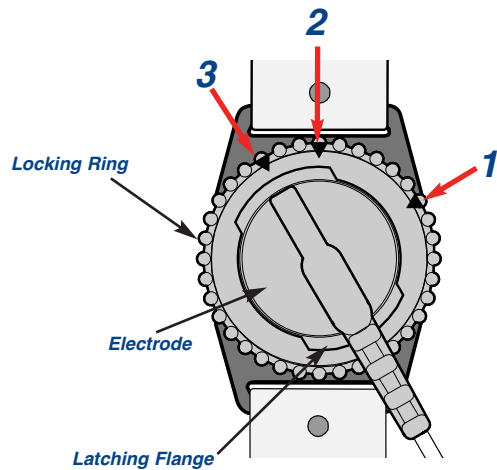

- a. Rotate the holder locking ring to align cut-outs with those of the underlying holder the arrow indicator should be at Position 1 (shown at left). Match the latching flanges of the electrode with the cut-outs and insert the gel-fitted electrode into the holder.
- b. Lightly press the electrode down against the skin and maintain pressure while rotating the locking ring **counter-clockwise** until the arrow indicator is in line with the holder strap holes (Position 2 at left). Release pressure on the electrode and continue to slowly rotate the locking ring **counter-clockwise** until the electrode clicks into the detent (Position 3 at left).



NOTE: Electrode wires must be securely taped to the patient's arm to prevent disturbing the gel-to-skin contact during iontophoresis. Use 1-inch surgical tape to secure wires firmly to the skin about 2 inches from each strain relief. Leave slack between taped area and electrodes to prevent strain to the electrode assembly.

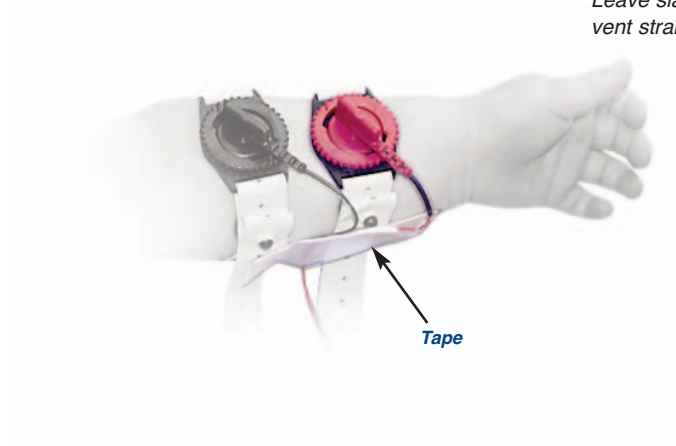

2.1 Performing the Sweat Test

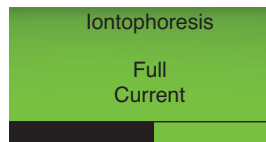

8 Activate Iontophoresis

- After completing Check Controls the arrow on the display should indicate Iontophoresis on the menu.
- Press **ENTER** to start iontophoresis. The display will show: **INCREASING CURRENT**. Once current has reached the full 0.5mA, the display will show **FULL CURRENT** and that level is maintained for 2 minutes. Once full current is achieved the Time Bar shows the remaining time. Current will then decrease to zero (indicated by a short beep). The display will show: **IONTOPHORESIS COMPLETE**.
- Press **ENTER** to return to the main menu.



9 Remove the Red Electrode

While applying pressure to the red electrode with the index finger, rotate the upper ring approximately 90° clockwise until the cut-outs align with the electrode flanges. Then remove the electrode.

CAUTION:

Do not disturb or remove the red holder. It must remain in place during analysis. In addition, leave the negative (black) electrode, gel, holder and tape-downs in position to provide a ground contact for initial sweat rate determination.

2.1 Performing the Sweat Test



10 Clean and Dry the Skin in the Collecting Area

Use a cotton swab to absorb any surface moisture from the entire skin area inside the holder, followed by clean dry swabs to completely dry the area. Without delay, proceed to the next step.

NOTE: *If the sensor is not inserted immediately, repeat the cleaning and drying procedure just before attaching the sensor.*



11 Insert Sensor Into Positive Holder

Insert the sensor (without being attached to the wiring harness) into the holder (red locking ring) as described in steps **7a** and **7b**, taking care not to disturb the holder or touch the bottom of the sensor.

Confirm that the Induction/Analysis module is **ON**.

2.1 Performing the Sweat Test

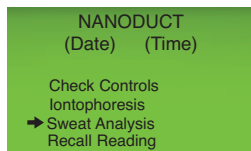

ENTER

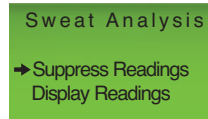

SELECT

ENTER

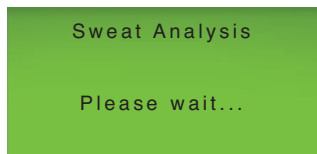

12 Connect Sensor to the Red Sensor Connector

With the sensor in the holder, press the sensor connector fully onto the red sensor, so that the two electrode pins seat in the mating receptacles (orientation is not important).

NOTE: *The sensor cable must be securely taped to the patient's arm approximately 2 inches from the strain relief. Be sure to leave enough slack in the cable on the sensor side of the tape-down to protect it from inadvertent tugging. Make sure the tape-down doesn't disturb the sensor's even contact with the skin surface. Make sure the black electrode cable is still securely taped down.*

13 Activate Sweat Conductivity Analysis

Immediately after the sensor is placed in the holder, Press **ENTER**.

The instrument will then prompt you to choose to display readings during testing or to suppress the reading for recall at a later time. Press **SELECT** to make your selection and then press **ENTER**.

NOTE: *A patient should produce sufficient sweat within 30 minutes after iontophoresis. If the Nanoduct does not detect sufficient sweat to report "Sweat at First Electrode" within 30 minutes, or 30 minutes has elapsed between seeing "Sweat at First Electrode" on the display and seeing sweat testing data appear on the display, the test should be aborted due to insufficient sweat production.*

2.1 Performing the Sweat Test

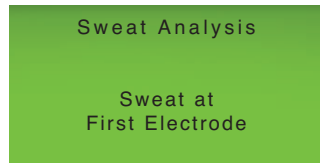

Display with readings suppressed

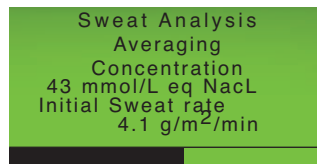

Display with readings shown

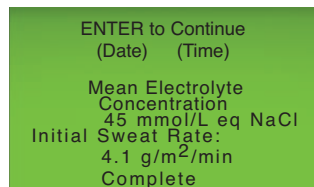

14 Record the Result

With the sensor in place, the display usually indicates sweat contact with the first electrode within a few minutes. After another 2 to 6 minutes (all timing is approximate) the conductivity display should begin to show continuous data (if **DISPLAY READINGS** has been selected). Simultaneously the initial sweating rate in g/m²/min is displayed. **If the black electrode is removed and the Initial Sweat Rate is reported as invalid, the result from the sweat test remains valid.**

The continuous data remains on display, and after 3 minutes, the display shows that averaging has commenced. The time bar at the bottom of the display indicates remaining time once sweat reaches the second electrode. The mean sweat conductivity is displayed after another 5 minutes.

This value is compared with the established conductivity ranges for children under 16 years (**normal = 0 to 60 mmol/L; equivocal = 61 to 80 mmol/L and CF = above 80 mmol/L**) for a diagnostic appraisal, and becomes the reported test result. A typical final display is shown at left. See Section 3 for complete information.

Once the test is completed the display flashes **COMPLETE** and the control module emits a short beep. The date and time the test was completed is displayed.

Press **ENTER** to return to the main menu.

2.1 Performing the Sweat Test

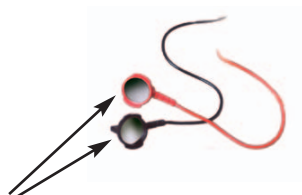
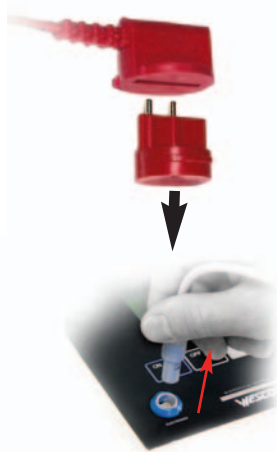

wash & dry metal plates

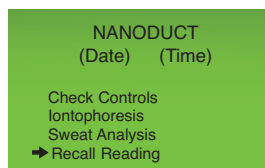

15

Remove Holders and Sensor, and Clean Electrodes

Disconnect the cable from the sensor, remove the sensor from the holder and discard the used sensor. Disconnect the cable plug from the socket of the Sweat Induction/Analysis module and turn **OFF** the power.

Remove the holders from the patient and gently wash and dry the entire skin areas involved in the test.

Wash and dry the electrode plates.

16

Recall the Display Reading

If you selected **SUPPRESS READINGS**, or if the control unit powers off, the last reading can be recalled by selecting **RECALL READING** on the display menu and pressing **ENTER**.

Recall Reading also outputs the last reading to the serial port where it can be printed if a serial printer is connected to the port.

SECTION 3
INTERPRETING THE
SWEAT TEST



3.1 *Units of Conductivity*

Electrical conductivity, essentially an electrical measurement, should properly be measured in siemens/cm. However, we use conductivity to indirectly measure electrolyte concentration. Since medical professionals are more familiar with standard chemical units (such as mmol/L) for concentration, the siemens/cm units have not been used for conductivity values in the practice of clinical chemistry, to prevent confusion. Wescor has retained the mmol/L (equivalent NaCl) unit used by other sweat conductivity instruments in the past. Unfortunately, this unit has also produced confusion in some quarters.

It is therefore important to define and explain the meaning of this expression. The readout, both as displayed continuously and as the electronically-averaged value is expressed in mmol/L (equivalent NaCl).

This means that the sweat sample has an electrical conductivity that is equivalent to that of an NaCl solution of the displayed mmol/L concentration (at the same temperature). **THE READINGS IN SUCH UNITS DO NOT REPRESENT THE ACTUAL CONCENTRATION OF EITHER SODIUM OR CHLORIDE IN THE SWEAT.**

The level of electrical conductivity is a function of the molar concentration of ionized molecules in a solution. Sweat samples are made up of sodium, potassium, and a small contribution by ammonium, as the cation contribution. The anions balancing these are mainly chloride, with lactate and bicarbonate. Thus, the conductivity can be seen as a measure of the total electrolyte in mmol/L. Clinical trials have amply demonstrated that sweat total electrolyte and sweat chloride are equally effective analyses in the diagnosis of CF. As there are other ions contributing to the conductivity other

3.1. *Units of Conductivity*

than sodium and chloride, the mmol/L (equiv. NaCl) value of a sweat sample will always exceed the actual molar sodium or chloride concentration as analyzed specifically. The diagnostic range is therefore different from that established for chloride.

The electrolyte selected for calibration reference happens to be sodium chloride but it could have been any other salt. The chemical nature of the calibration solution is immaterial, because the reference ranges for sweat conductivity will be based upon comparison with the calibration value, and will be valid whatever electrolyte is used as a reference. For example, if lithium nitrate had been selected as the reference salt, it may have produced a possibly different but equally reliable and effective reference range. Conductivity values would then have been expressed as mmol/L (equivalent LiNO_3). Though such an alternative calibration option is not recommended, it would have had the advantage that since no mention of sodium or chloride is made, the results would not be mistakenly seen as representing actual sweat sodium or chloride levels.

3.2 Automatic Averaging

Automatic Averaging

Examination of the data showing the relationship between sweat conductivity and time after attaching the sensor, obtained on all the subjects in the original test of the system, and typically shown in Fig.1, allowed the selection of optimal settings for the averaging circuitry. After a variable lapse of time (Period A, Fig.1) during which the sweat is gradually filling the channel in the sensor, it reaches the second electrode, thereby completing the conductivity cell circuit and producing a displayed conductivity reading. During the next 3 minutes (Period B, Fig.1), this reading usually falls sharply, and then assumes a steady rate of decrease that is maintained thereafter.

This initial rapid change has been termed the “first sample phenomenon” and the reason for it is not yet clear. In the steady phase of decrease of conductivity, the average rate of decrease is about 15% per 10 minutes (during the period 10 to 20 minutes after the first reading). The best time period for averaging commences after the initial rapid fall stabilizes, that is at 3 minutes from the first reading, thus avoiding the “first sample phenomenon”. It then continues for the next five minutes (Period C, Fig 1) during which the sweating rate is still near-maximal.

The induction/analysis module is therefore programmed to make an average conductivity assessment by noting the time at which the first conductivity result is displayed, allowing a time lapse of 3 minutes and then commencing a 5 minute averaging period, after which the mean value is displayed.

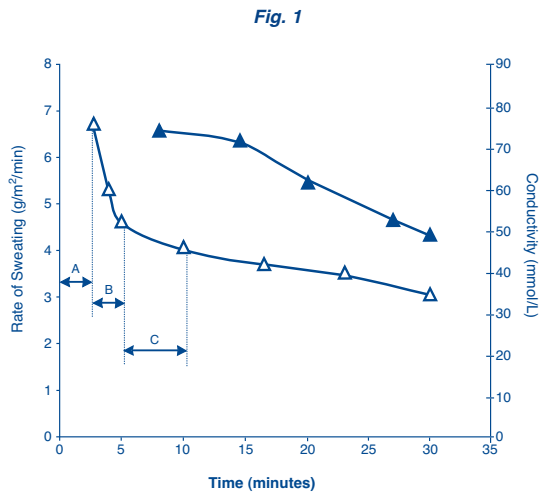

△ Conductivity v Time

▲ Rate of Sweating v Time

3.3 Diagnostic Ranges

Normal = 0 to 60 mmol/L*

Equivocal = 61 to 80 mmol/L*

CF = above 80 mmol/L*

*equivalent NaCl

Using the data displayed in Fig 1, which show both sweat rate and conductivity variation with time after stimulation, the Nanoduct averaged value (over period C) was obtained (46 mmol/L). This can be compared with the value (47 mmol/L) that would theoretically have been obtained using a Macroduct-obtained mixed sweat yield over 30 minutes, the standard collection time used in the clinical trial that provided the basic results for the selection of the currently-established normal, equivocal, and CF diagnostic ranges. It is clear that the Nanoduct results may confidently be evaluated with reference to these ranges, for children under 16 years of age, **normal 0 to 60 mmol/L, equivocal 61 to 80 mmol/L, and CF above 80 mmol/L. (equivalent NaCl).**

In non-CF adults, the normal range is frequently extended into the equivocal levels, but never sufficiently to provide false positive diagnosis.

3.4 *Initial Sweating Rate*

One advantage of the unique continuous-flow sensing device of the Nanoduct System is that it allows computation of the initial sweating rate. The volume of the sensor channel from the first electrode to the second electrode contact is precisely known, as is the collecting surface area. After the sensor is attached to the arm, the time taken for this volume to be filled with sweat is measured by the Induction/Analysis module.

Applying an algorithm with the fill time as the sole variable allows a display of the initial sweating rate in the conventionally accepted units of grams per square meter of skin surface per minute. This datum is available when the first reading is displayed on the continuous record of conductivity.



SECTION 4
TROUBLESHOOTING AND PREVENTIVE
MAINTENANCE



4.1 Troubleshooting

SYMPTOM	CAUSE/SOLUTION
High resistance fault during iontophoresis.	<p>High skin or electrode-to-skin resistance.</p> <p>Inspect the electrodes and clean if necessary. Place a drop of deionized water directly on the clean skin beneath the pilogel disk.</p> <p>Make sure the electrodes are secured with adequate tightness to the patients limb.</p>
Open loop fault during iontophoresis.	<p>Loose electrode or broken cable. Be sure both electrodes are inserted into the holders and that the cable is connected to the control unit.</p>
Over current fault during iontophoresis.	<p>Control unit may be damaged.</p> <p>Do not continue to run or use the control unit. Contact Wescor for further instructions.</p>
Control unit immediately shuts off.	<p>Battery voltage too low. Replace battery. Control unit failure. Contact Wescor for further information.</p>
Low battery display.	<p>Low battery voltage. Replace battery.</p>
Display remains blank when turned on.	<p>Dead battery. Replace battery.</p>
Display does not change from "Waiting For Sweat."	<p>No sweat detected.</p> <p>Check expiration date on Pilogel. Check that straps are secure and cable is connected to control unit. Inspect cable for any damage.</p> <p>The patient's sweat rate may be very low. Wait sufficient time to allow sweat to flow. (Not to exceed 30 minutes.) Orifice on sensor cell blocked.</p>
Set Clock menu is displayed when instrument is turned on	<p>Battery for clock is dead. Replace clock battery.</p>

NOTE: This instrument is designed and tested to meet EN61326 standards for electromagnetic compatibility for laboratory equipment. However, if you suspect electromagnetic susceptibility or interference, reorient or relocate the equipment to correct the problem.

4.2 Cleaning the Instrument



When needed, the induction/analysis module surfaces and accessories should be wiped down using a soft cloth dampened with mild detergent or 10% household bleach solution.

Electrodes must be cleaned following each iontophoresis procedure as follows:

- 1** Remove any remaining gel from electrodes.
- 2** Use a cotton ball or swab moistened with purified water to clean each electrode thoroughly.
- 3** If the electrode appears dirty after an extended idle period, or will not clean with steps 1 and 2, use a small round piece of light duty cleaning pad (such as 3M Scotch Brite™ #7445) to buff the electrode surface.

CAUTION!

Never use harsh abrasives such as steel wool, sandpaper, or emery cloth to clean electrodes. Never scrape electrodes with metal tools. If the electrode surface is scratched or pitted it will not perform as specified and must be replaced.

4.2 *Cleaning the Instrument*

Use the following options to clean Nanoduct straps, holders and attachment strap retainers or any other parts that come into contact with a patient:

Option A:

- 1 Soak the straps for 30 minutes in a freshly prepared 10% dilution of household bleach.
- 2 Rinse soaked straps thoroughly in tap water.
- 3 Allow to air dry.

Option B.

- 1 Autoclave the straps for 30 minutes at 121 °C.

CAUTION:

Do not autoclave the Nanoduct holders (red or black) or the attachment strap retainer post. Autoclaving will destroy these parts.

4.2 *Cleaning the Instrument*

Option C: Treat straps as disposables

1 Discard straps after each use.

2 Purchase new straps from Wescor (See Appendix B for complete information. Contact Wescor for current prices and ordering information.

4.3 Battery Replacement



1 The battery compartment is on the bottom of the induction/analysis module. Turn the unit on its side to access the battery compartment. Use a flat bladed screwdriver or similar tool to lift the battery pack out of its receptacle.

2 Remove the spent battery from the holder.



3 Replace with a 9 volt lithium or alkaline battery (ANSI/NEDA 1604).

4 Push the battery pack back into the instrument until the retaining latch engages.

5 Dispose of the spent battery according to battery manufacturer's instructions and local regulations.

NOTE: *If the instrument will be unused for an extended time, remove the battery. Batteries can leak and damage terminals if left unused for extended periods.*

4.4 Calibration and Checking Control Values

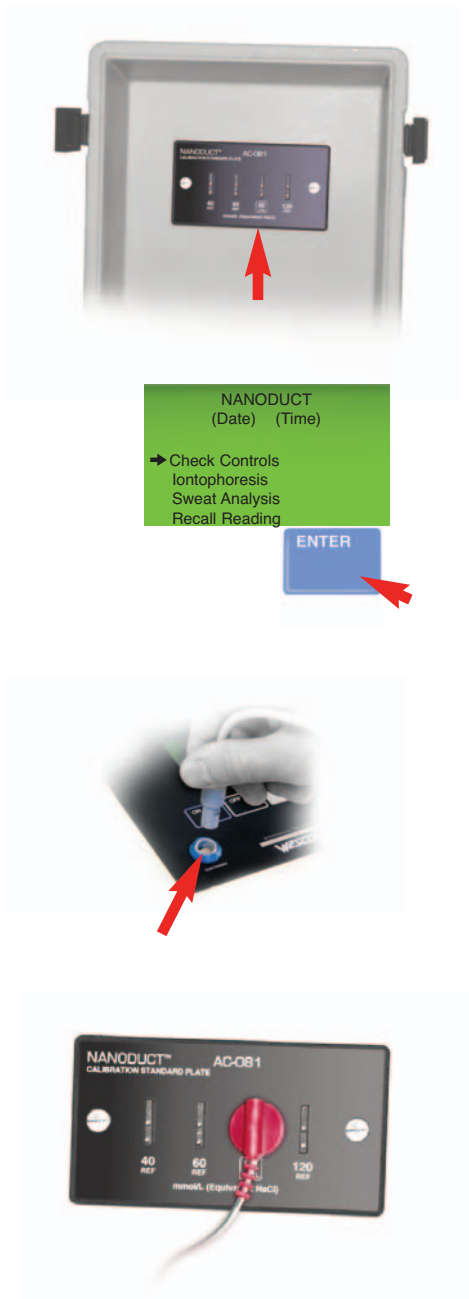

Patient Simulator

Wescor offers the Patient Simulator for those who wish to measure unknown samples as part of a proficiency study or to verify or validate the function and accuracy of the Nanoduct instrument. Contact Wescor for more information.

NOTE:

This instrument uses an extremely stable single set point calibration. The calibration plate is provided to verify that the instrument is functioning properly and to allow for re-calibration when necessary.

The calibration plate has one calibration value, 80 mmol/L (equivalent NaCl) and three control values: 40, 60, and 120 mmol/L (equivalent NaCl).

Instructions:

- 1 Select "Check Controls" on the menu and press **ENTER**.
- 2 Connect the electrode cable assembly to the electrode socket and connect the sensor cell connector to the 80 CAL connection on the calibration plate. Select "Calibrate" and press **ENTER**. The instrument will now calibrate to 80 mmol/L and display "80 mmol/L eq NaCl" when completed. Optionally for checking control values, connect the sensor cell connector to any of the 3 control values. The selected value will show corresponding mmol/L eq NaCl ± 1 .

Refer to the following page to see how this procedure is followed using the display screen prompts.

4.4 Calibration and Checking Control Values

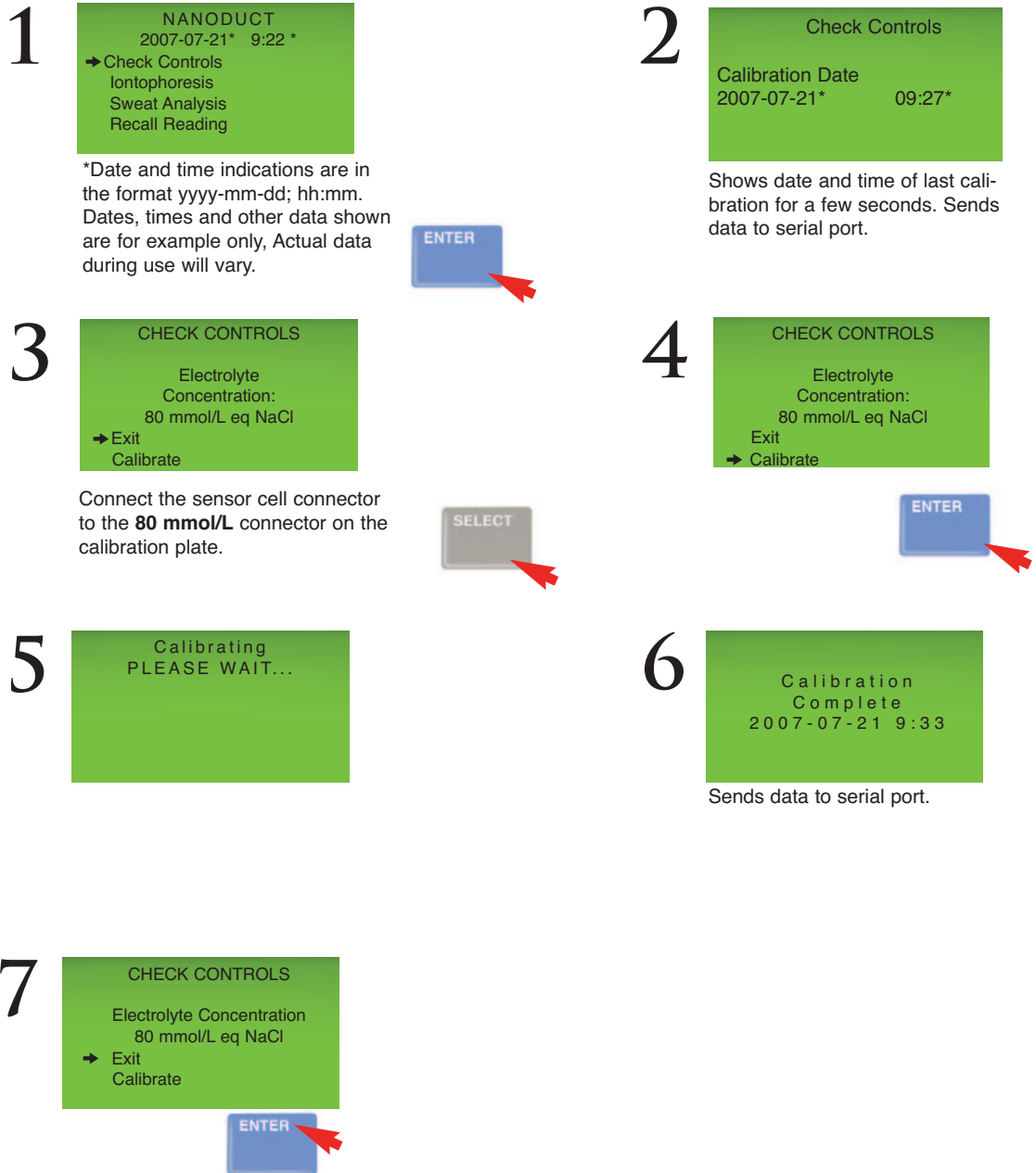



APPENDIX A
SPECIFICATIONS



Readout	128 x 64 dot graphic. Supports up to 8 lines of 18 characters or numerals, with multi-lingual support.
Sound	Alert and Alarm signals.
Keyboard	ON, OFF, SELECT and ENTER keys.
Electrode Connection	6 pin locking medical connector to mate with induction/conductivity cell, cable.
Serial Connection	9 pin connector compatible with RS232.
Electrical	One 9.0 Volt Lithium battery (Alkaline battery may be used) 100 milliwatt power use during operation. Typical solid-state, over-current circuit protection. 3.0 Volt lithium coin cell for real time clock.
Sweat Induction Control	Current profile controlled for use with Pilogel® iontophoretic disks with multiple fail-safe circuits to limit current. Nominal current is 0.5 (±0.02) mA for 2.5 minutes (± 0.2 Sec.) Maximum fail-safe current limited to 5 mA.
Sweat Analysis	Conductivity with readout in mmol/L (equivalent NaCl). Range 3 to 200 mmol/L (equivalent NaCl). Error 1% or less from 25 to 150 mmol/L (equivalent NaCl). Initial sweating rate reading 0 to 50 g/m ² /min. Single point automatic calibration 80 mmol/L (equivalent NaCl).
Real Time Clock	± 2 minutes per year.
Operating Temperature	15 to 30 degrees C.
Storage and Transport Temperature	0 to 60 degrees C.
Regulatory	Meets EN 61326 Standards for EMC compatibility. Meets IEC 60601 standards for safety. Manufactured under Wescor's quality system (ISO 13485: 2003). Bears the CE mark as a Class IIa medical device. Certificate issued by BSI 0086.
Physical	Housed in portable carrying case. Storage compartment for supplies. Handle for ease of carrying.
Height	16 cm.
Width	23 cm.
Depth	33 cm.
Weight	Less than 2.25 kg.



APPENDIX B
ACCESSORIES, SUPPLIES,
& REPLACEMENT
PARTS



ACCESSORIES

Calibration Plate	AC-081
Nanoduct Patient Simulator	AC-111

SUPPLIES

Nanoduct Supply Kit for 6 sweat tests	SS-043
Nanoduct User's Manual	RP-360

REPLACEMENT PARTS

Nanoduct Control PCB Assembly	Factory Service Only
Electrode Cable Assembly	RP-359
Strap Retainer Post	RP-353
Positive Red Electrode and Sensor Cell Holder	RP-357
Negative Black Electrode Holder	RP-358
Holder Attachment Strap, Small, 1 each	RP-354
Holder Attachment Strap, Medium, 1 each	RP-355
Holder Attachment Strap, Large, 1 each	RP-356
Case Latch, 1 each	RP-347
Clock Battery, 1 each	RP-238



APPENDIX C
SUPPLEMENTAL INFORMATION



Cystic Fibrosis: A Brief Description of the Disease

Cystic fibrosis of the pancreas (or mucoviscidosis) is due to one of the many known 'inborn errors of metabolism' that are fundamentally the result of aberrations in the structure of the genetic material. It is classed as lethal because of the very poor prognosis afforded to sufferers. The inheritance is autosomal recessive, so that an affected child must inherit one defective gene from each of the parents to be homozygotic. Such parents must then at the least be carriers (heterozygotes). The distribution of the genetic anomaly varies with racial types. It is predominantly associated with Caucasians in whom it occurs in about 1 in every 1500 to 2000 live births.

The symptoms of the disease are manifold, however they are not strictly specific and hence physicians often have difficulty in distinguishing CF from other childhood diseases on the basis of medical diagnosis alone. The most serious clinical features are the pulmonary problems stemming from abnormally viscous exudates in the lungs, requiring urgent physiotherapy and antibiotic treatment to offset the ever-present risk of pneumonia. The pancreas is also affected by over-viscous secretions that reduce its output of digestive enzymes, thus the child tends to fail to thrive because the food ingested passes through the alimentary canal without the normal enzymic breakdown necessary for absorption of nutrients. Fortunately, the latter problem is relatively easily corrected by the addition of animal pancreatic extracts to the diet. The use of "pancreas" in the disease name arose because of the identification (in 1938) of pancreatic abnor-

malities during post-mortem examination of children that had died with a set of symptoms that were not as yet associated with a specific illness. It should be noted here that CF sufferers may differ quite widely in the degree to which they exhibit the various symptoms. Some may be relatively less affected in the respiratory airways, others may show more serious pancreatic problems. A feature of the inheritance is that carriers do not exhibit the symptoms of CF.

In 1953, it was found that children afflicted by the disease are prone to acute hyponatremia during hot weather. Investigations on the cause of the loss of sodium showed that the eccrine sweat of children with CF contains 3 to 4 times as much salt as that of unaffected subjects. Subsequent work showed that this salt increase is not observed in presumed carriers. This was the first intimation that a laboratory test for the disease was conceivable. The sweat test was born, and remains to this day the principal laboratory diagnostic test for this disease. In recent years the discovery of "the CF gene" promised a new laboratory diagnostic approach. Intensive studies of this gene have revealed hundreds of variants that may, or may not, produce the typical CF symptoms.

There is no doubt that this research will in the future illuminate the effects of different genetic abnormalities on the biochemical patterns of the individual. However, the sweat test will remain the definitive laboratory diagnostic test for some time yet.

Evolution of Sweat Test Methods

The sweat test has traditionally involved three separate, sequential procedures — stimulation of the sweat glands, collection of their secretion, and sweat analysis. Early stimulation procedures involved total body heating followed by placing the patient in a bag, or, later by heating followed by collection from a limited area of skin covered by a hermetically-sealed absorptive pad. Both of these methods endangered the infants and proved unsatisfactory. The heating was eventually avoided by using pilocarpine iontophoresis to induce the glands to sweat maximally. Following this, the sweat was collected in a pre-weighed pad and re-weighed, eluted and analyzed.

The method is usually known as the Gibson and Cooke¹ pad absorption sweat test or the QPIT (quantitative pilocarpine iontophoresis test). This procedure has persisted over the years and is still being performed, particularly by CF centers. It is time-consuming and tedious, requiring many manipulations where human error may intervene, and in one particular step offers technical difficulties that virtually ensure some degree of error, particularly when the sweat sample size is very small.

Laboratorians in CF centers who specialize in this method develop the requisite skill to maintain reasonably accurate results, but this is generally not the case in outlying clinics and hospitals, where the test is only occasionally requested, leading to unacceptably high risk of false results.

While the iontophoretic transport of pilo-

carpine into the glands has remained the universally preferred method of sweat stimulation to this day, the need for a simpler method of collection and analysis spawned the development of alternative procedures during the late 60's and early 70's. Principally among these were the cup-collection systems, which used electrical conductivity for analysis, and the direct skin chloride electrode system.

These methods were highly innovative, procedurally simpler than the Gibson and Cooke method, and were initially commercially successful. They nevertheless failed in their objective to eliminate false diagnostic results. The adoption of these new procedures on a wide scale exacerbated the problem, evoking a storm of criticism in the professional literature, with calls for a return to the original pad-absorption which was now regarded as the "reference method"^{2, 3, 4}. In fact, CF referral centers in the United States, operating under accreditation of the Cystic Fibrosis Foundation were forbidden to use any sweat test method other than the QPIT.

These early attempts to simplify the sweat test failed for two principal reasons: (1) error intrinsic to the method of collection and beyond the control of the operator, or (2) extreme susceptibility to variations in operator technique. The direct skin chloride electrode, though offering unrivaled simplicity, was very prone to operator variability in manual skill, and gave poor results due mainly to great difficulties experienced in the control of evaporation error.

Evolution of Sweat Test Methods

The cup collection method was examined for potential intrinsic error by Webster⁵ who found that the phenomenon of condensate formation on the walls of the plastic cups was the principal cause of the trouble. His quantitative measurements of the degree to which this occurred in unheated plastic cups showed that the error was always significant and very often reached proportions sufficient to produce false positive results. The error was avoided by using a metal collector cup that was maintained at above skin temperature throughout sweat collection, condensation was prevented and the error disappeared.

In 1978, Wescor introduced the Model 3500 Webster Sweat Collection System that employed an electrically-heated metallic collector cup.⁶ It was the first “simplified” sweat collection system worthy of comparison with the Gibson and Cooke method, it enjoyed considerable success, and was free from any criticism by users and related professionals. It was however burdened by a problem common to all cup-collection systems, that is, the need to “harvest” the sweat accumulated beneath the cup during collection.

Wescor’s determined commitment to resolve this problem eventually led to the invention of the MACRODUCT® Sweat Collector.⁷ This innovation completely supplanted the heated cup, while retaining its advantages by the use of a collector that anaerobically collected sweat by using the hydraulic pressure of the sweat glands to pump the secretion directly from the ducts into a fine-bore capillary tube. This system has been very successfully employed both

in the US and internationally since 1983.

Vested in Wescor’s scientific and engineering staff is a combination of many years experience in laboratory sweat testing and in the development of modern electronic instrumentation. The Wescor aim in the field of sweat testing has always been to provide quality instrumentation to meet a number of criteria.

1. Elimination of all intrinsic sources of error concomitant to previous collection methods.
2. Ensuring impeccable accuracy in the diagnostic result by reducing human error potential to the lowest possible level.
3. Maximization of patient safety and comfort.
4. Maximization of operator convenience within the strictures imposed by objectives 1, 2 and 3.

These objectives have led to considerable innovative improvements in all aspects of sweat testing, iontophoretic safety measures, collection methods and also in the analytical phase of the test. With the introduction of the Model 3600 MACRODUCT Sweat Collection System in 1983, all of the comprehensive objectives had been accomplished. Paramount among the system’s several unique features was the innovative MACRODUCT disposable sweat collector.

Development of the Nanoduct Neonatal Sweat Analysis System

During almost twenty years of successful deployment of the Macroduct Sweat-Chek System it began to be realized that a truly neonatal sweat test was needed, one that preserved the error-free anaerobic handling of the sweat sample employed in Macroduct, yet at the same time was particularly designed to meet the special requirements of the newborn infant during the first two weeks of life.

In the interests of effective early management of newborn CF patients it is highly desirable that a definitive laboratory diagnosis be made as early as possible, allowing prompt initiation of appropriate medical procedures, especially those correcting malnutrition due to pancreatic deficiency and those protecting the infant from airway problems. The frequency of "insufficient sweat," or "no sweat" reports from laboratories has been unsatisfactorily high throughout the history of sweat testing on very young infants. Recent years has seen increasing emphasis on "screening tests" to newborns, particularly the combination of immuno-reactive trypsin assays and genotype analysis. Both of these have been very useful, but have not reached the status of a definitively diagnostic procedure as has the sweat electrolyte test.

The reason for sweat test failures is well understood by those professionally charged with sweat test performance. The size of iontophoretic electrodes and collection paraphernalia is usually inappropriately large for effective use on the extremely small and frail limbs of the newborn. Many technologists are wary of attempting this daunting task due to the distinct possibility

of causing a burn, and also because of the risk of producing a false result in the pad-absorption test by inability to control evaporation and condensation errors, particularly when handling tiny infants and dealing with low sweat yields. The Macroduct System, which employs the smallest electrodes and collector of all methods used up to 1998, is nevertheless frequently found to be inappropriately-sized for tests with neonates. It is obvious that any attempt to devise a sweat test for newborn babies must involve, as a fundamental requirement, equipment for iontophoresis and collection that is scaled down to minimal dimensions, enabling their effective application to extremely small limbs.

It is also evident that this approach, taken alone, would merely aggravate the problem by limiting even further the number of sweat glands involved and thereby reduce the sweat yield to as little as 3-6 microliters in 15 minutes collection. In such cases the traditional methods for gathering the sample, storing it in a sealed container, and taking aliquots for presentation to an instrument for analysis would clearly not be feasible, because the potential for serious error would be very difficult, if not impossible, to control.

Such limitations could be avoided if no attempt was made to collect the minute sweat yield. Instead, the sweat is channeled from the sweat duct openings in such a way that it passes directly and anaerobically into a conical collecting interface, just as it does in the Macroduct device, and thence to a microbore tube within the collector that is equipped with

Development of the Nanoduct Neonatal Sweat Analysis System

electrodes and becomes a conductivity cell for analysis of electrolyte concentration. Research and development at Wescor provided evidence that this approach was feasible, and sweat tests using the prototype equipment illustrated the simplicity and ease of operation of the method and the speed at which definitive results could be obtained.

In effect, the apparatus, called the Nanoduct Neonatal Sweat Analysis System,⁸ incorporates a flow-through conductivity cell that provides, in situ, continuous readings as the sweat enters it from the sweat ducts. This type of data has not been available in any test method to date, making the Nanoduct unique. All other methods involve analysis of a mixed sample obtained over the whole collection period. The sweat is not seen, nor is it collected as a visible sample.

With the development of this neonatal procedure, the opportunity presented itself to make desirable modifications with the aim of improving the safety and shortening the time of iontophoresis, and to provide the electrode gels with protection against accidental freezing.

This method was first published in the *Annals of Clinical Biochemistry* in 2000.⁸

References

1. Gibson, L. E., Cooke, R. E., A test for concentration of electrolytes in sweat in cystic fibrosis of the pancreas utilizing pilocarpine iontophoresis. *Pediatrics* 1959; 23: 545-9.
2. Gibson, L. E., The Decline of the Sweat Test. Comments on Pitfalls and Reliability. *Clin Pediatr.* 1973; 12: 450-3.
3. Rosenstein, B. J., Langbaum, T. S., Gordes, E., and Brusilow, S. W., Cystic fibrosis: problems encountered with sweat testing, *JAMA*, 240, 1987, 1978.
4. Gibson, L. E., Cooperative study comparing three methods of performing sweat tests to diagnose cystic fibrosis.
5. Webster, H. L., and Lochlin, H., Cystic fibrosis screening by sweat analysis. A critical review of techniques, *Med J. Aust.*, 1, 923, 1977.
6. Webster, H. L., and Barlow, W. K., New approach to cystic fibrosis diagnosis by use of an improved sweat-induction/collection system and osmometry, *Clin. Chem.*, 27, 385, 1981.
7. Barlow W. K., and Webster H. L., A simplified method of sweat collection for diagnosis of cystic fibrosis. Proceedings of the 9th International Cystic Fibrosis Congress. Brighton, England, June 9th-15th 1984. Lawson D. (ed), John Wiley & Sons, New York; 1984; 204.
8. Webster H. L., Quirante C. G., Micro-flowcell conductometric sweat analysis for cystic fibrosis diagnosis. *Ann Clin Biochem*, 2000 Vol. 37, 399-407.

APPENDIX D
USING THE SETUP
MENU



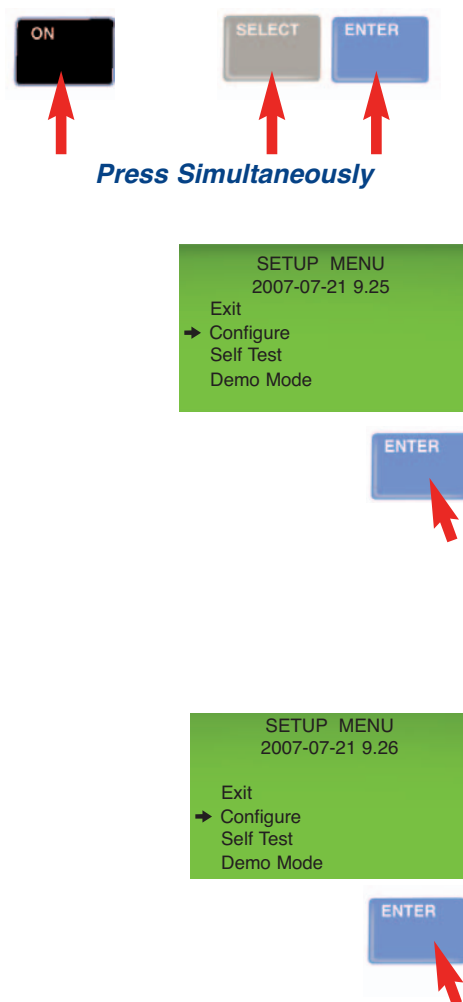

The Setup Menu allows you to configure the instrument for your use, to run an instrument self test, or to operate the instrument in a demonstration mode.

Accessing the Setup Menu:

- 1 While pressing and holding down the **SELECT** and **ENTER** keypads, press the **ON** keypad. After a few seconds, the display will show: "SETUP MENU."

Make selections by pressing **ENTER** when the pointer is next to your choice.

Select "Exit" to return to the main operation menu.

Using the Configure Option

The Configure Option allows you to set the clock, change the display language, set options such as default status for suppressing or displaying test results, and forcing a Calibration Check when the instrument is turned on.

- 1 Select "Configure" from the Setup Menu and press **ENTER**.

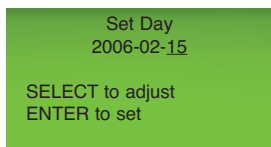
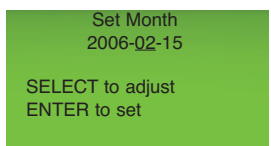
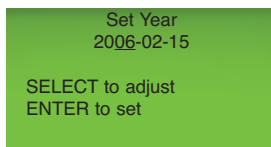
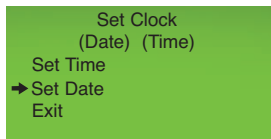
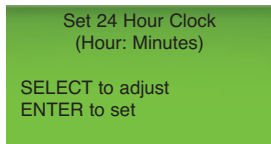
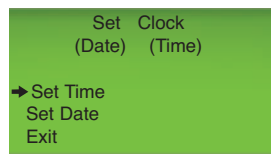
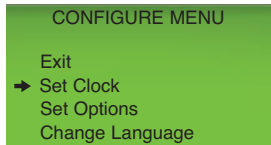

Setting or Adjusting Time and Date Display

Setting Time

1 To set or adjust the time on the clock, select “Set Clock” in the **CONFIGURE MENU** and press **ENTER**. Then select “Set Time” and press **ENTER**.

2 The display shows the “Set 24 Hour Clock” menu with either the hours or minutes flashing. Select hours first and enter the correct hour and press **ENTER**. Then select “Minutes” and enter the correct minute. Then press **ENTER**.

Setting Year, Month and Day

1 Select “Set Date” and press **ENTER**.

2 While the year position is flashing, press **SELECT** to adjust the year. Then press **ENTER**.

3 While the month position is flashing, press **SELECT** to adjust the month. Then press **ENTER**.

4 While the day position is flashing, press **SELECT** to adjust the day. Then press **ENTER**.

Press **EXIT** to return to the previous **MENU**.

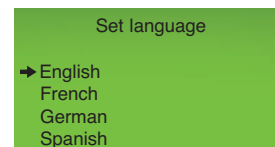
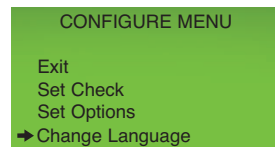
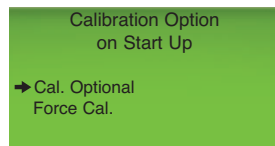
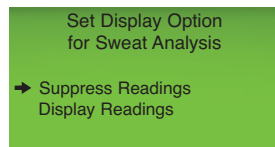
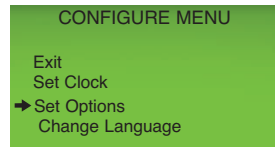

Setting or Adjusting Options

1 While in the **Configure Menu** select “Set Options” and press **ENTER**.

2 To either display or suppress the results of the sweat test, select either “Suppress Readings” or “Display Readings” and press **ENTER**.

3 The Calibration Option menu allows you to automatically go to the Check Controls menu on power-up of the instrument. Choose “Force Cal.” for this option or “Cal. Optional” to calibrate only when you need to. Press **ENTER** when you have made your selection.

Setting Language Options

1 You can set the display language in the configure menu. Select “Change Language” and then press **ENTER**.

2 Select the desired language and then press **ENTER**.

Select and press **ENTER** to return to the **SETUP MENU**.

APPENDIX D
USING THE SETUP MENU

Self Test displays

```

SETUP MENU
Date Time
Exit
Configure Menu
→ Self Test
Demo Mode
    
```

```

Self Test Mode

ENTER to Continue

#, ## Battery Volt
    
```



```

Self Test Mode

ENTER to continue

Connect Electrodes
to check current
### m. A.
    
```

```

Self Test Mode

ENTER to Continue
Connect to
Calibration Plate
to check operation
## mmol/L eq NaCl
    
```

```

Self Test Mode

ENTER to Continue
Connect to Printer
SELECT Key
To test Serial
Communication
    
```

Demo Mode displays

```

DEMO MODE
Date Time
Exit
Check Controls
→ Iontophoresis
Sweat Analysis
    
```

```

Iontophoresis
DEMO MODE

Full Current
    
```

```

Sweat Analysis
DEMO MODE
Electrolyte
Concentration
## mmol/Leg NaCl
Initial Sweat Rate
#. # g/m2/min
    
```

Using the Self Test

The Self Test allows testing of current output, conductivity, and battery voltage.

To use the Self Test, select “Self Test” in the Setup Menu (see the far left column of displays).

CAUTION:

Do not run Self Test while the module is connected to a patient.

Using the Demo Mode

The Demo Mode is used to simulate typical displays that are seen during normal operation. This can be useful for demonstrating instrument function or to familiarize the user with the instrument. No actual iontophoresis or sweat analysis occurs in this mode and only simulated results are shown. In this mode the instrument functions much like it would when running on an actual patient. The display screen and menu appears as it would during an actual test with the exception that “Demo Mode” appears at the top of the display and the Check Controls option is not available while in this mode. The instrument must be operated in Normal Mode in order to check controls or calibrate. While running in this mode, the ENTER key acts as a shortcut key and advances the instrument through the phases of the operation allowing you to see the next display without waiting for the full instrument countdown.

APPENDIX E
PILOCARPINE
IONTOPHORESIS:
REQUIREMENTS AND RISKS



In common with all sweat test procedures for the diagnosis of cystic fibrosis since the inception of the sweat test, sweat must be induced in order to be analyzed.

In modern medical practice the sweat glands in a limited area of the skin are stimulated by local application of cholinergic drugs, particularly pilocarpine. These substances are introduced to the glands by iontophoresis (in the case of pilocarpine). These drugs act by mimicking the action of the natural physiological gland stimulator, acetylcholine, which is liberated at the gland by signals from the autonomic nervous system. The iontophoretic procedure depends upon the application of a small and brief direct current to the skin via electrodes, the anode of which, being positive, drives the positively-charged pilocarpine from the reservoir of drug sufficiently to reach the glands.

The requirements for Pilocarpine, as defined in the Wescor Quality Procedures, are primarily that the form and source of the drug be pilocarpine nitrate and the purity being that specified by the United States Pharmacopeia (USP Grade). The concentration of aqueous pilocarpine nitrate solution should be sufficient to initiate a maximal sweat-yielding response from the glands. The Wescor concentration for Nanoduct meets this requirement at a minimal level of 1.5%. Where positively-charged salt ions (acting as iontophoretic transport competitors) are absent from the drug solution, the requirement may be met by 1.0% pilocarpine. The literature on pilocarpine shows no evidence of allergic

sensitivity to the drug.

Wescor gel drug reservoirs are quality controlled to meet these requirements in Pilogels manufactured in-house, using spectrophotometric procedures to check the pilocarpine content of the gels in each batch.

Burns Under Iontophoresis

Minor skin burns have been an unwelcome, adverse side-effect of pilocarpine iontophoresis from the beginning. Unusual sensitivity to pilocarpine has sometimes been assumed to be the cause of "burns" but there is no firm evidence for this contention. Majority opinion seems to support the proposition that some types of stimulating apparatus are prone to cause burns, particularly when associated with procedural error.

Such burns are extremely rare with Wescor sweat stimulating systems. They use a sophisticated microprocessor controller and a very low total delivery current (0.5 milliamperes in the Nanoduct System). Pilocarpine is contained in unique gel reservoirs. The gels also include compounds that further protect the patient from skin damage by preventing acid accumulation, by minimizing the risk of gel breakage, and by substantially reducing the time of electrical drug transport. These features markedly reduce, but do not entirely eliminate, the possibility of skin burns.

Most individuals exhibit a mild erythema (redness) at the skin stimulation site. In some cases one or more blister-like welts may also form. These are often mistaken for burns, but are more likely to be a temporary reaction to the passage of electrical current. Such “blisters” invariably disappear within 2 or 3 hours, leaving no after-effects.

Based on current data and reported events, the apparent burn rate using Wescor instruments is less than 1 in 50,000. The low rate is due to Wescor’s insistence on proper test procedures together with built-in equipment safety provisions that minimize the risk of even mild skin injury. It is highly unlikely that patients will suffer a burn during the stimulation phase of the sweat test.

We realize these statistics will be of scant comfort to the parents of a child who has the misfortune of suffering the “1 burn in 50,000.” However, experience has shown that when burns do occur, the injury is minor with little or no scarring.

APPENDIX F
SERIAL DATA OUTPUT





Data is automatically sent out on the serial port whenever “Recall Reading” or “Check Controls” is selected from the main menu. If a printer is correctly connected to the serial port, the data can be printed or the data can be captured with the use of a computer. The output from the Recall Reading selection will be the date, time and result from the last sweat test completed. The output from the Check Controls selection will be the date, time, and calibration value from the last calibration. In addition, if a new calibration is completed, the new date, time, and calibration value will be transmitted to the printer or computer.

The Nanoduct serial port uses a DB9 connector on the instrument front panel. This port is for asynchronous serial communication with a printer or computer. It uses standard non-return-to-zero (NRZ) format at RS-232 voltage levels.

SERIAL OUTPUT TECHNICAL DATA

Output voltage level:

Nominal ± 9 volts
Maximum ± 15 volts
Minimum ± 5 volts

Data protocol:

9600 bps
1 Start bit
8 Data bits
No parity
1 Stop bit

By entering Self Test Mode the following serial output can be sent “DATE TIME PRINT TEST.” This can be used for testing the printer and cable.

APPENDIX D
SERIAL DATA OUTPUT

Pin Diagram:

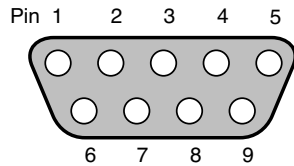

Pin #	Mnemonic	Description
1	N/C	No Connection
2	RXD	Receive Data (output)
3	TXD	Transmit Data (input)
4	N/C	No Connection
5	GND	Signal Ground (passive)
6	N/C	No Connection
7	N/C	No Connection
8	N/C	No Connection
9	N/C	No Connection

The serial port is configured as Data Communications Equipment (DCE). This enables the Nanoduct to be connected directly to most computers which are usually configured as Data Terminal Equipment (DTE). Most printers are configured as DCE, in which case a null modem cable is required.

Data output is in ASCII characters.

Reading format of output:

___ DATE TIME READING
mmol/L eq NaCl.

Calibration format of output:

CAL DATE TIME 80
mmol/L eq NaCl.

INDEX



- Accessories** 47
- Alkali Accumulation (during iontophoresis)** 8
- Anodic Acidification** 8
- Automatic Averaging** 21, 25, 27

- Battery**
 - low 10, 18, 33
 - replacement 10, 37
- Buffer (see Trisodium Citrate)**
- Burns Under Iontophoresis** 65-66

- Cable Assembly** 9, 13, 18
- Cable Connector Socket** 9
- Calibration** 38-39
- Citrate Buffer (see Trisodium Citrate)**
- Conductivity**
 - automatic average 9, 21, 25
 - cell 10
 - measurement 9, 10, 21, 25, 26, 27
 - Units of 10, 21, 25, 26
- Configure Option** 59-60
- Current**
 - DC 6
 - flow indicator 18
- Customer Service** 3
- Cystic Fibrosis (CF)** 6, 54

- Diagnostic Ranges** 28
- Display** 9, 10, 21
 - language settings 61
 - suppressed readings 10, 60

- Environmental limits** 4
- Electrode(s)**
 - anodic (positive) 7, 14, 18
 - cable assembly 7, 13
 - cathode (negative) 7, 14
 - cleaning 34
 - color coding 8
 - flanges 7
 - inspection 13
 - installing 16, 17
 - iontophoresis 7
 - reference 7
- First Sample Phenomenon** 27

- Fault Condition** 9
 - low battery 9, 10, 33
 - open electrode 9, 33
 - circuit 9, 33
- Flanges** 17

- Glycerol** 8
- High Resistance** 14, 33
- Holder(s)** 7, 13, 14, 22
 - straps 13, 14, 15
 - rings 16, 17
- Induction/Analysis Module** 6, 7, 9, 10, 13, 20, 22
- Iontophoresis** 6, 9, 13, 16, 18, 61, 62
 - current 6, 18, 61, 62
 - time 18
- Initial Sweating Rate** 9, 21, 29
- Keypads**
 - ON 9, 18
 - OFF 9, 22
 - ENTER 9, 18, 21
 - SELECT, 9, 21
- Latching Flanges** 17
- LCD Readout (See Display)**
- Low Battery Indicator** 10, 18, 33

- Microconductivity cell (see conductivity cell)**
- ON Switch (see Keypads)**
- Open Loop Fault** 33

- Patient Simulator** 38, 47
- Pilogel® Iontophoretic Discs** 8, 13, 16, 33, 65
- Pilocarpine Iontophoresis (See iontophoresis)**
- Pilocarpine** 8, 65-66
- Power Supply** 43

- Quality Control** 8
- Recall Reading** 22
- Replacement Parts** 47

- Self Test Option** 62

- Sensor** 8, 13, 18, 20, 21, 27
 - cable 20
 - connector 7, 13, 20
 - flanges 8
 - socket 9
- Setup Menu** 59
- Skin**
 - condition 14, 65-66
 - electrical impedance of 14
- Specifications** 43
- Supplies** 47
- Suppress Reading** 22
- Sweat**
 - analysis 6, 9, 10
 - analysis results 10
 - chloride in 26
 - contamination of 14
 - flow 7
 - glands 14, 61
 - sodium levels 26
 - stimulation 9, 61
 - rate 7, 21, 33
 - test 21

- Trisodium Citrate in Pilogels** 8
- Troubleshooting** 33

- Units of Conductivity Measurement** 10, 21, 25, 26